

THE WARLOCK OF FIRETOP MOUNTAIN (PART 2)

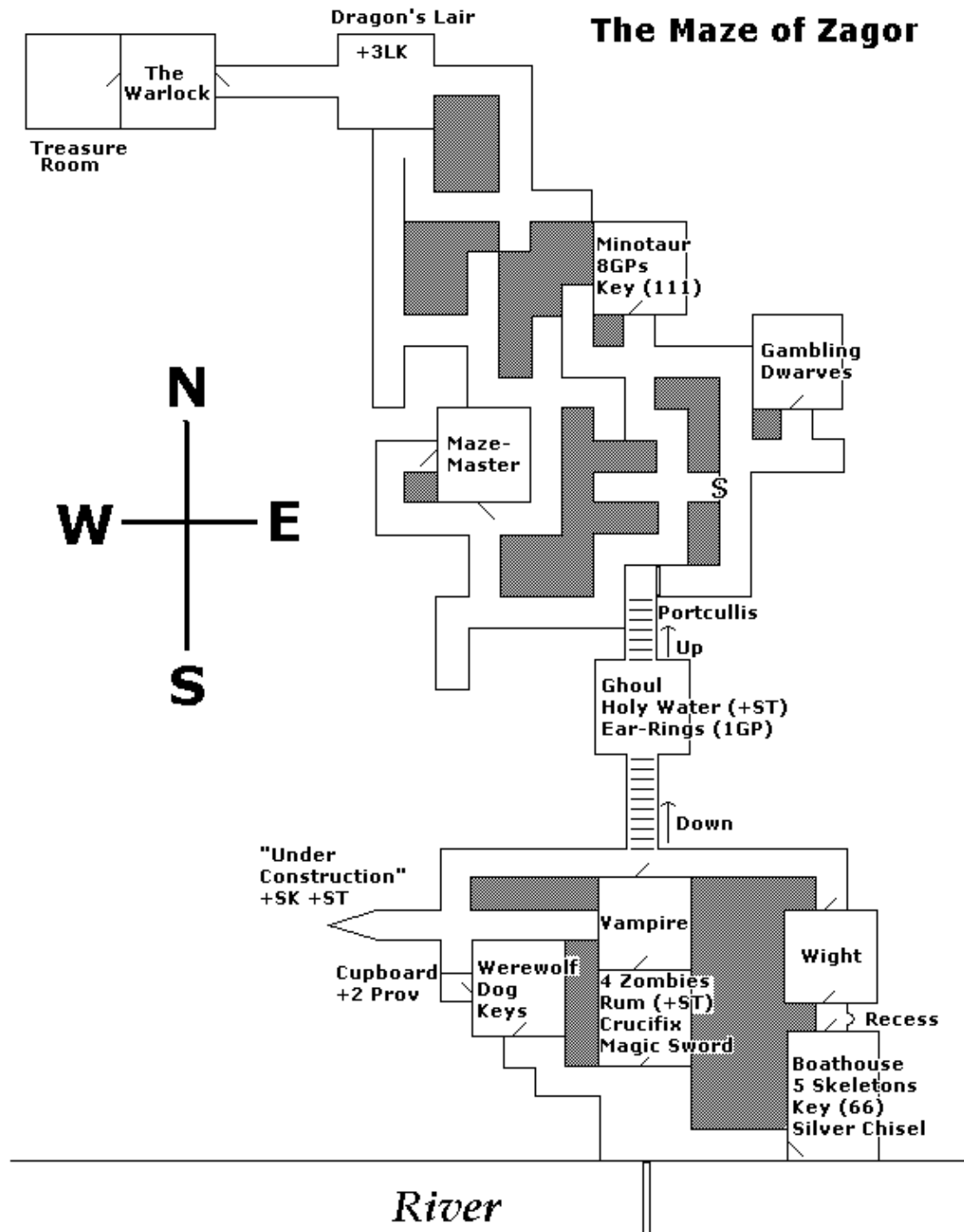

The Black Tower

The Citadel of Chaos

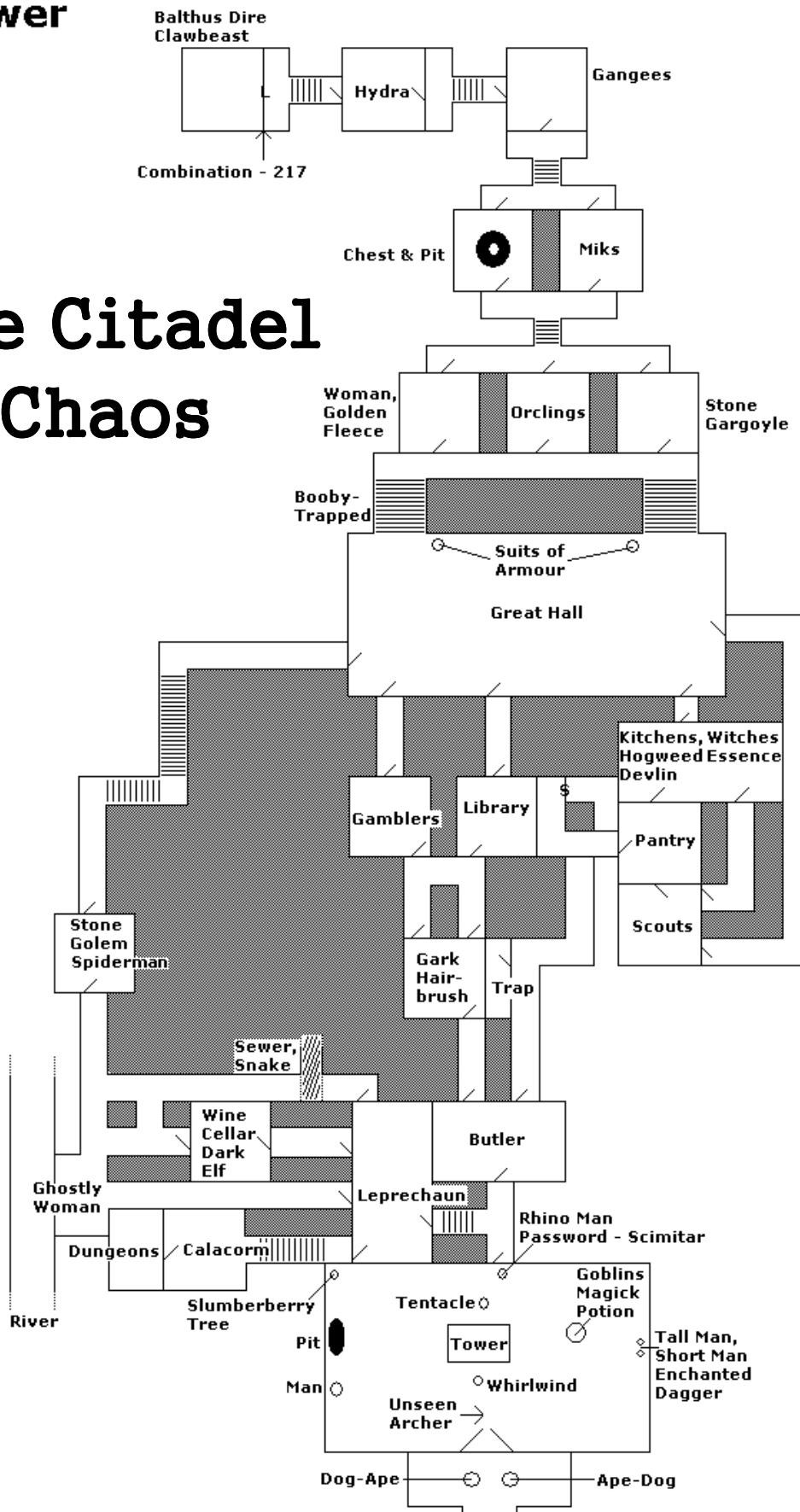

Fighting Fantasy Solution Maps

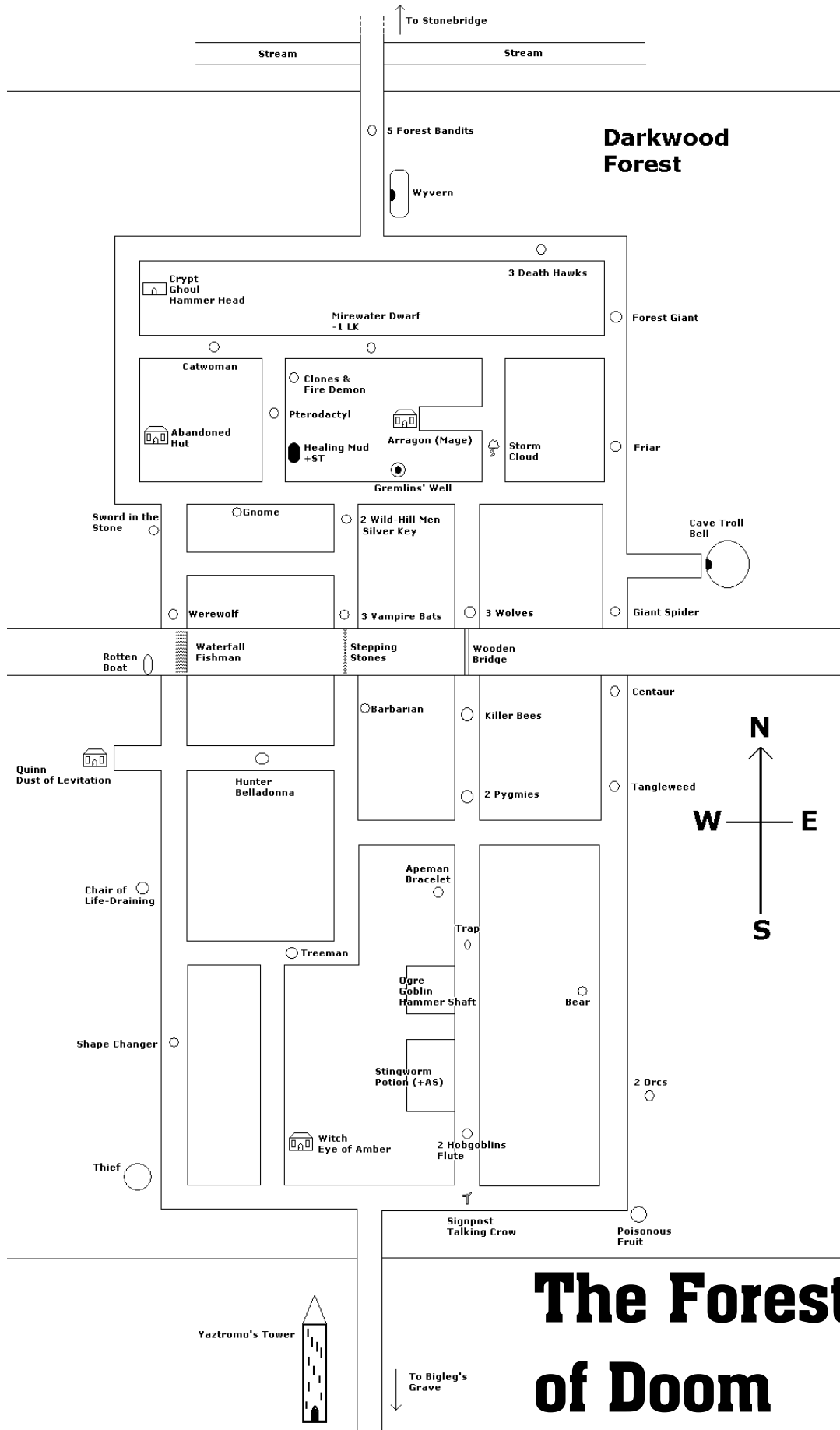

The Forest of Doom

Fighting Fantasy Solution Maps

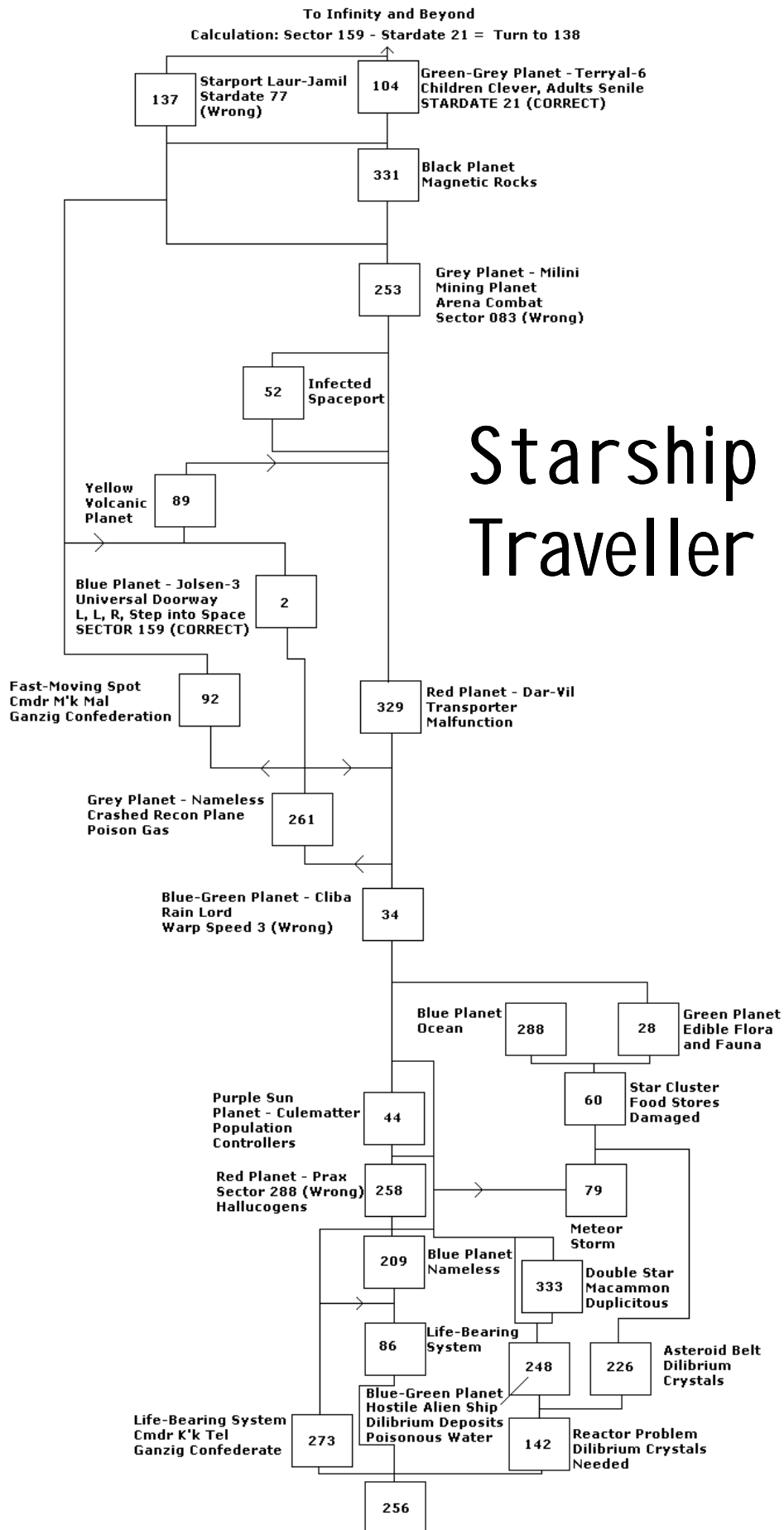

DEATHTRAP DUNGEON

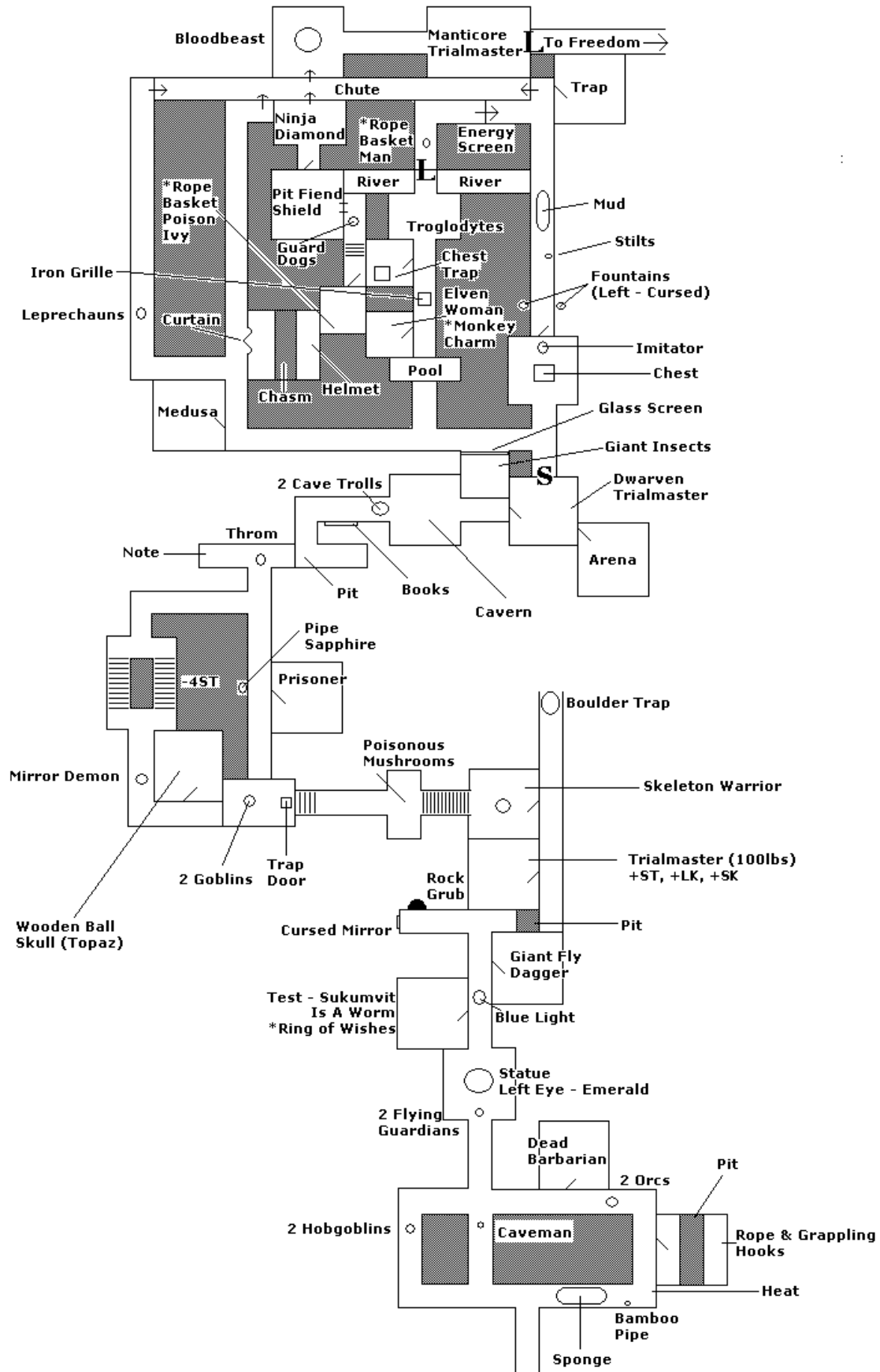

Island of the Lizard King

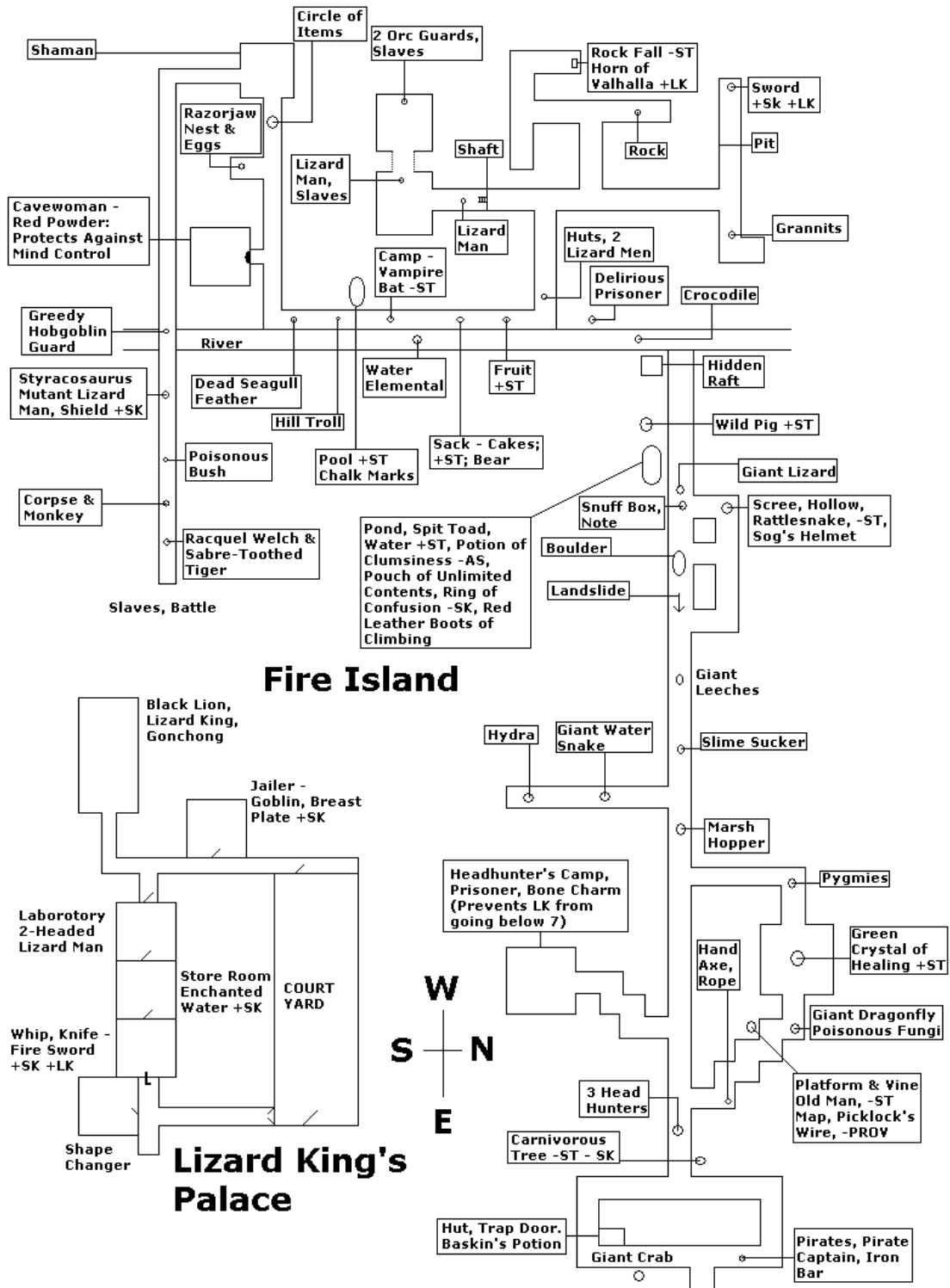

Scorpion Swamp

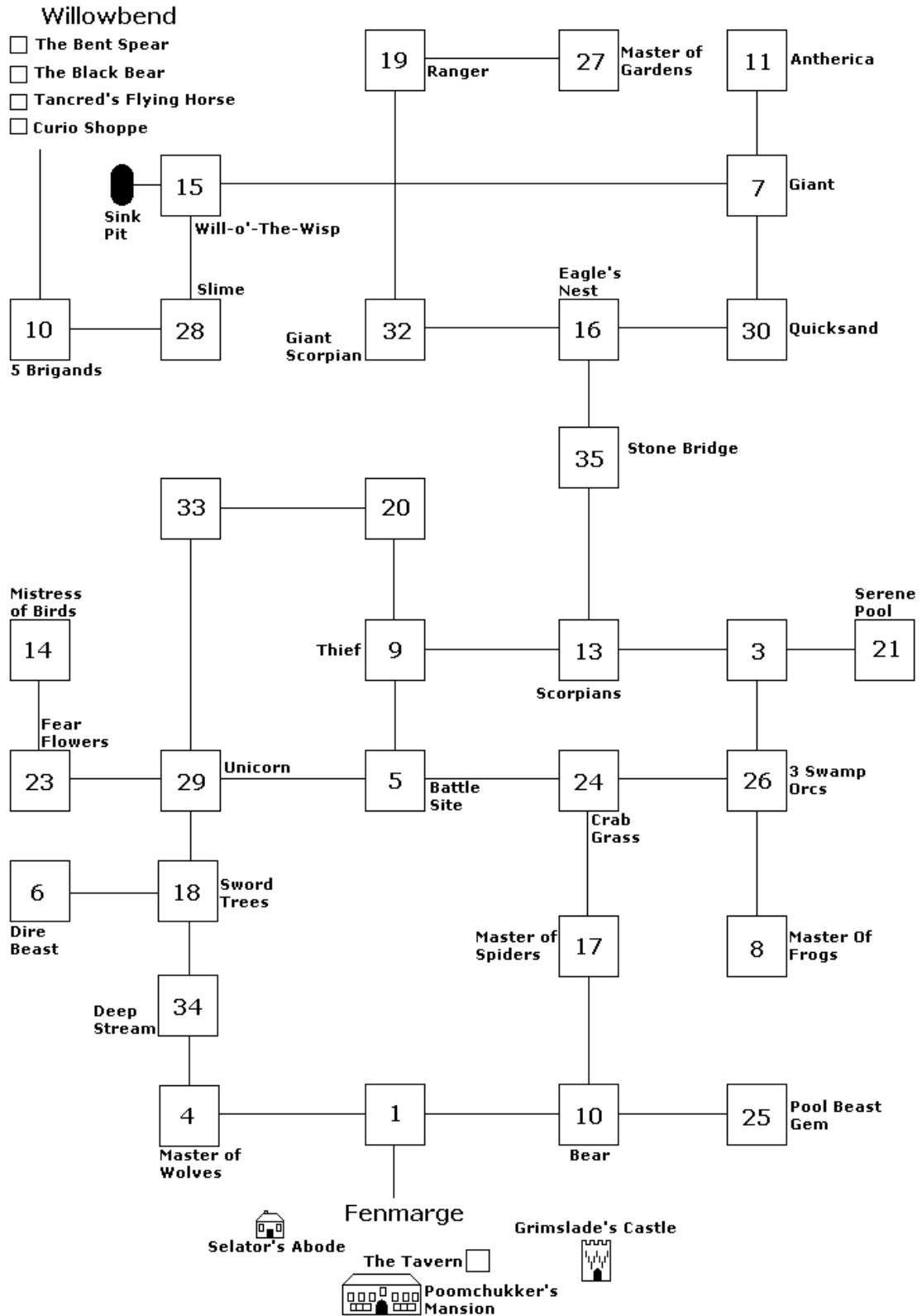

Caverns of the Snow Witch (Part 1)

The Crystal Caves

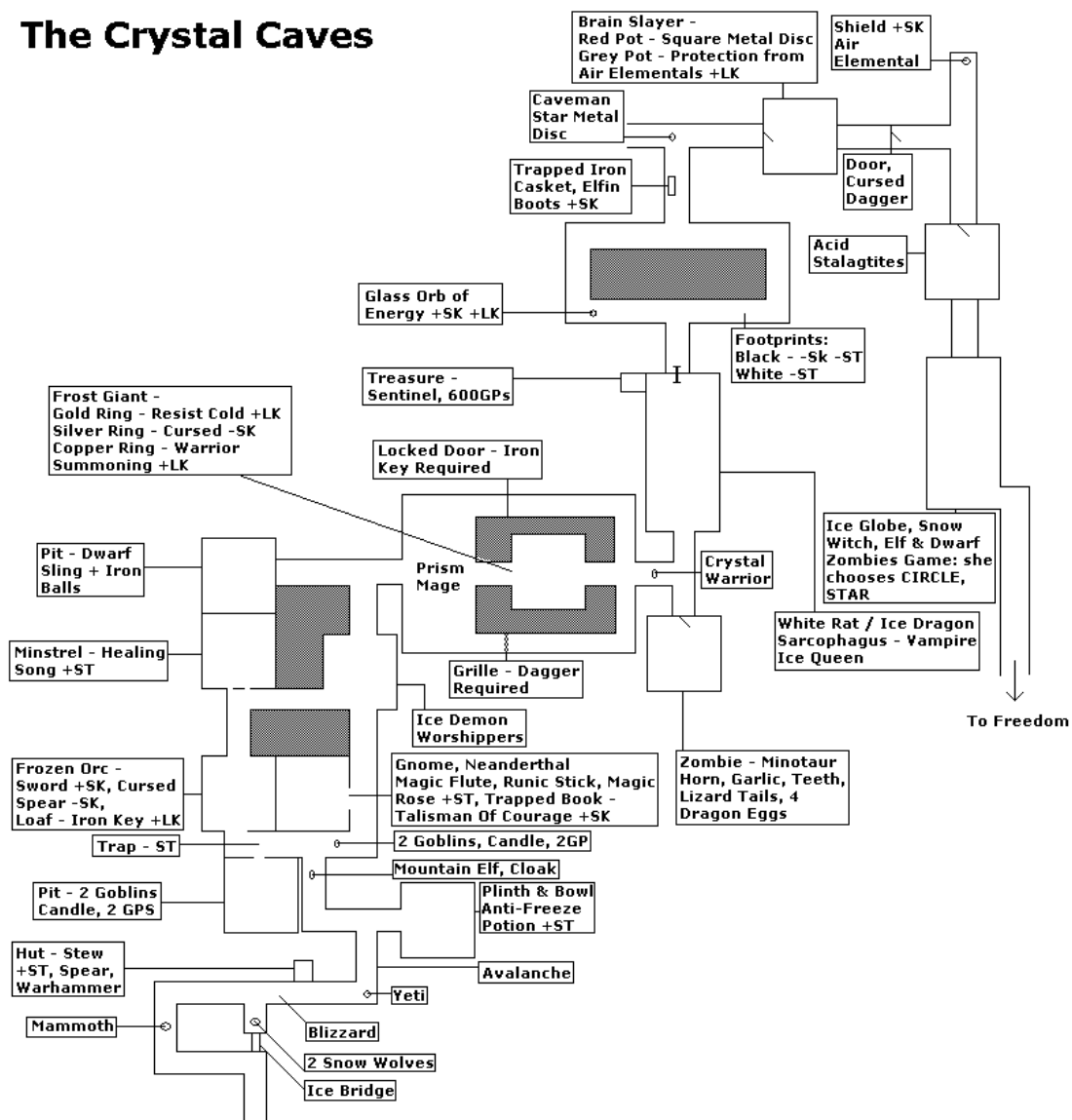

Caverns of the Snow Witch (Part 2)

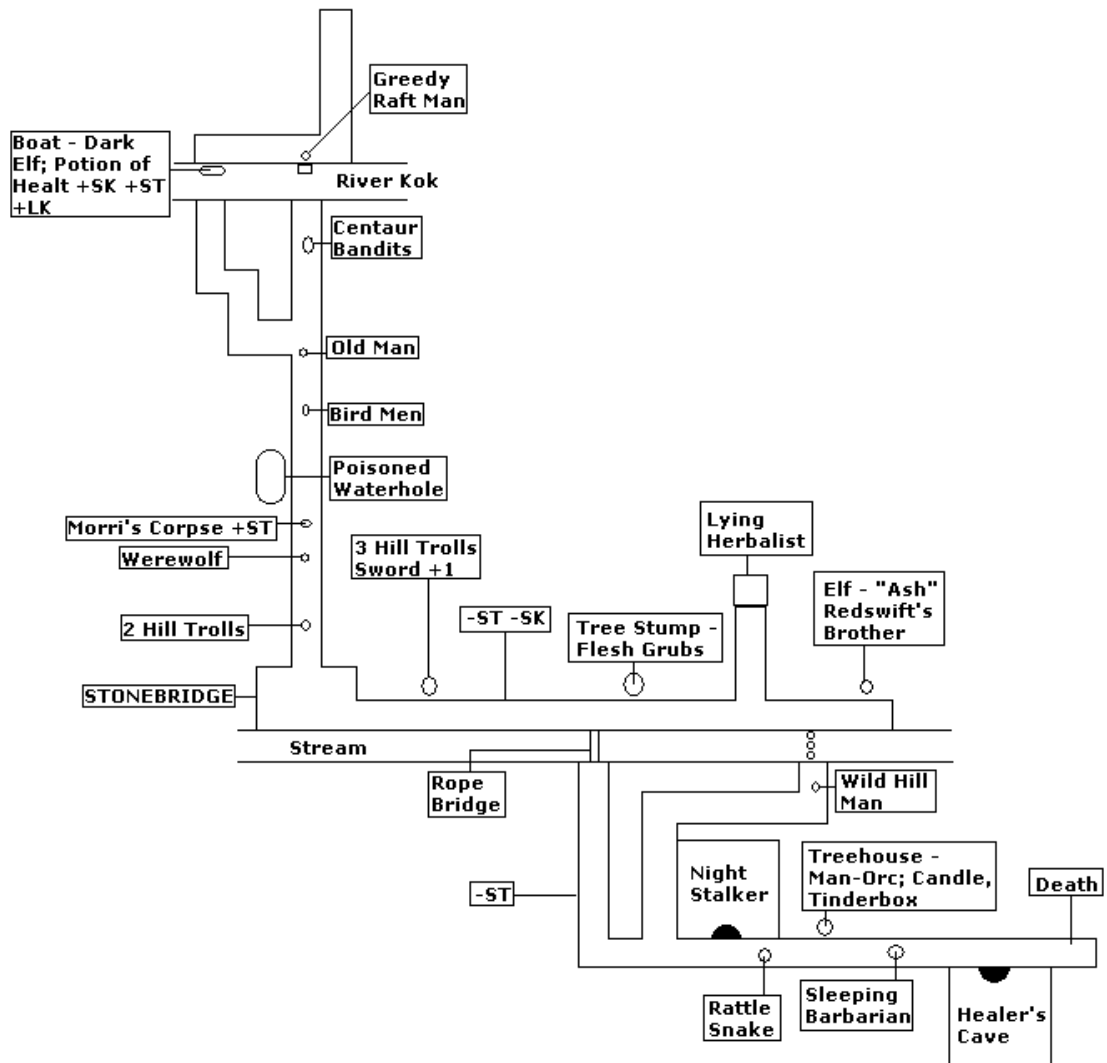

Orb - City of Greyguilts Talisman of Death (Part 1)

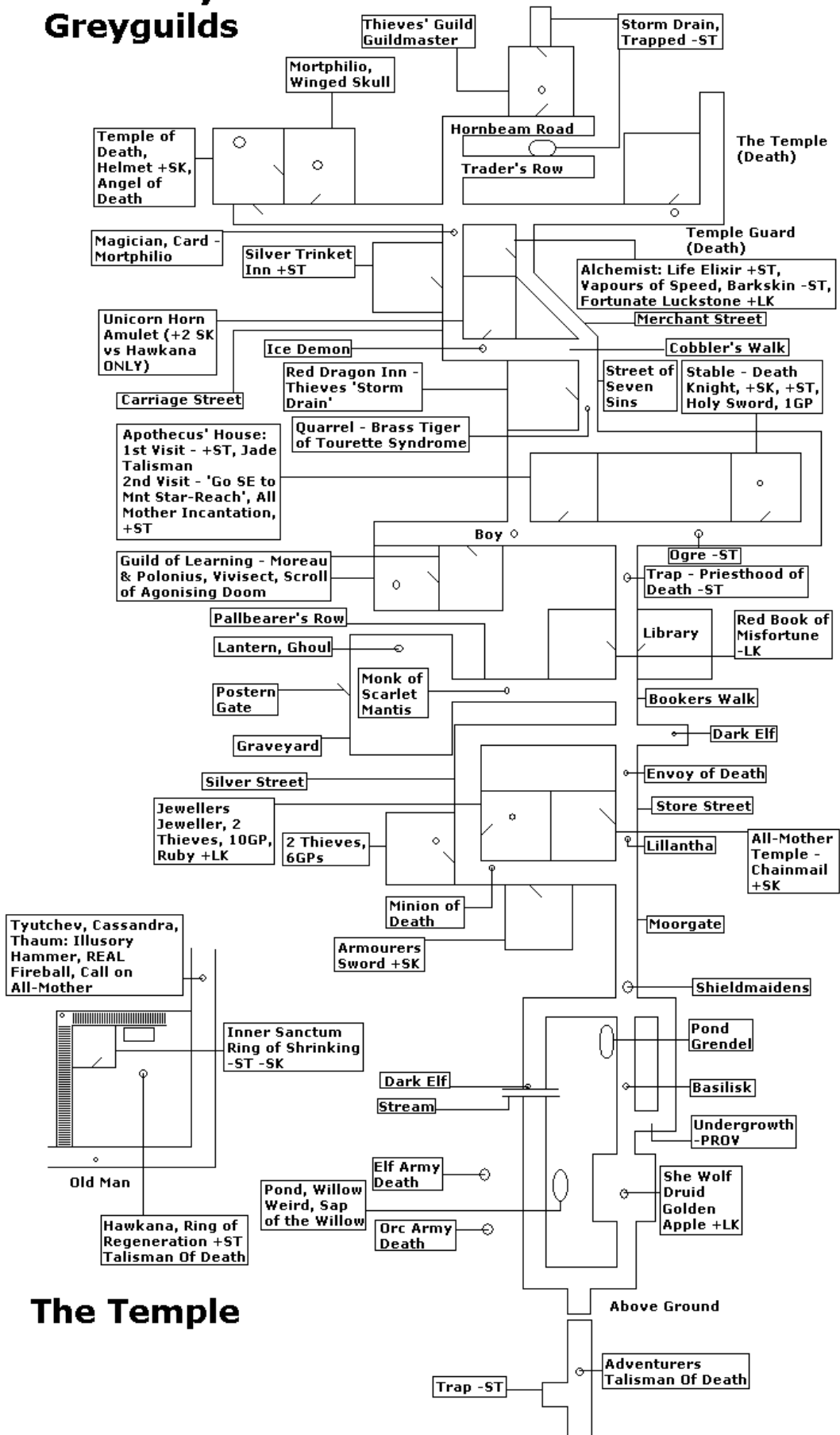

Talisman of Death (Part 2)

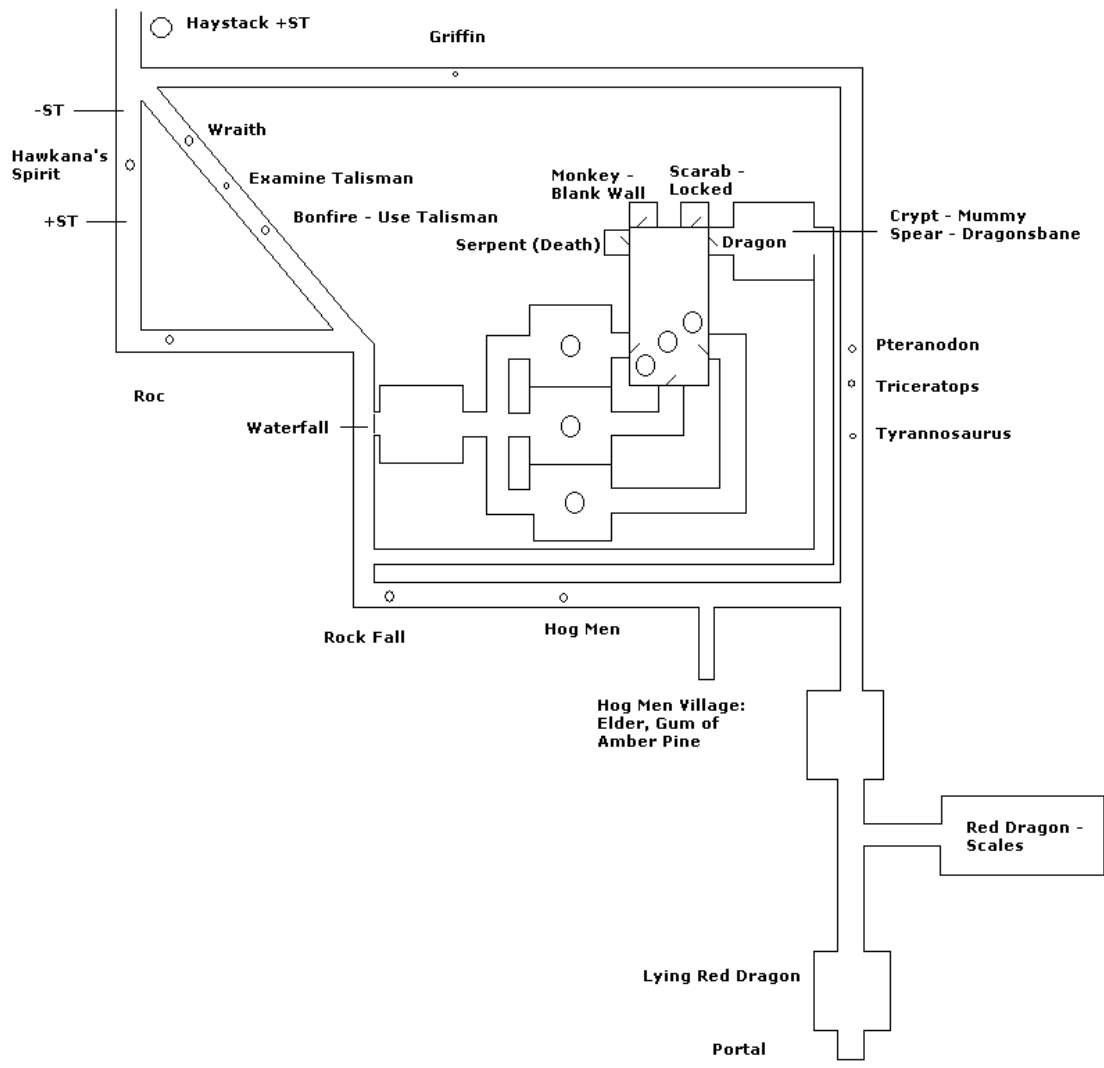

SPACE ASSASSIN (PART 1)

The Vandervecken

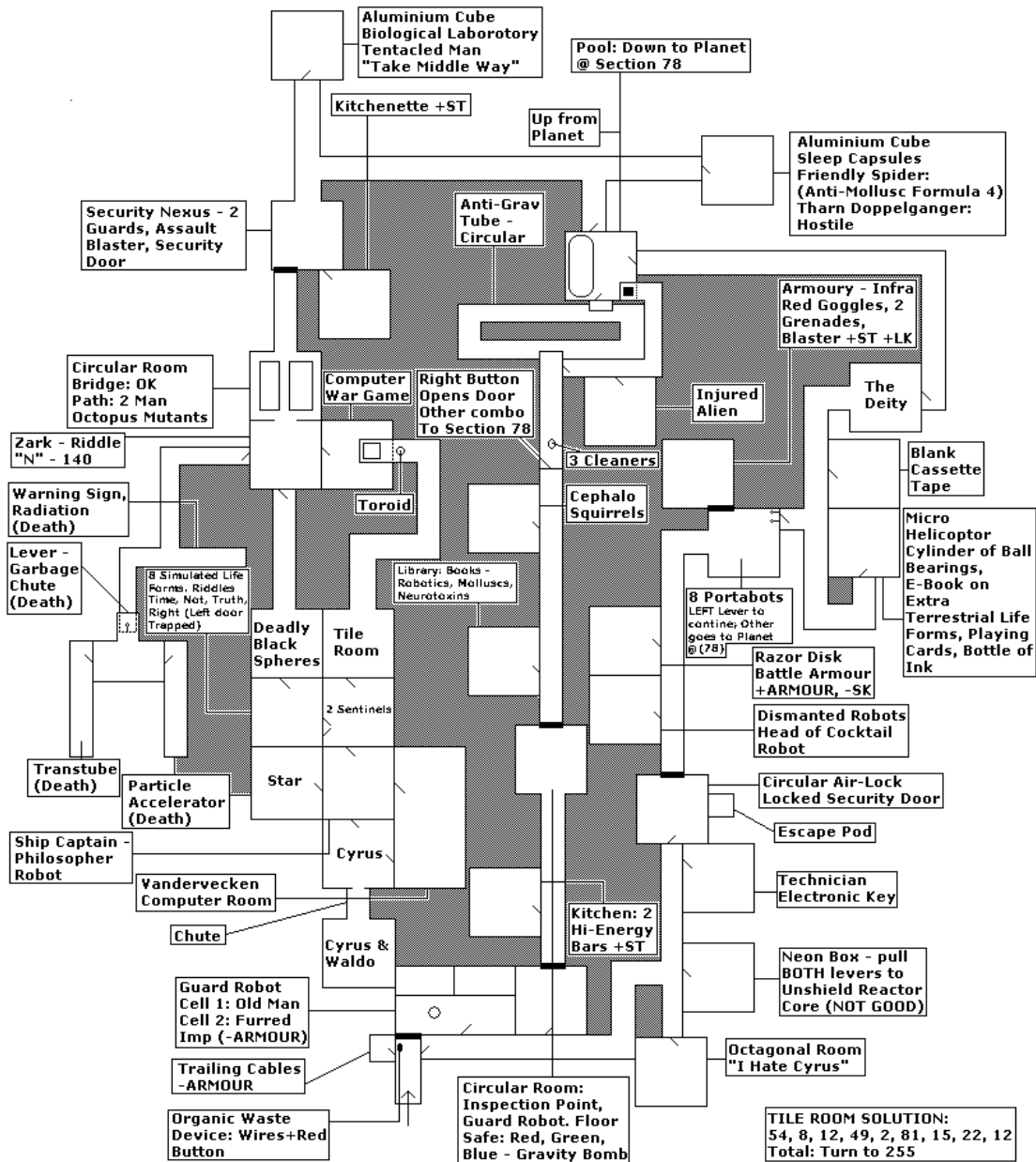

SPACE ASSASSIN (PART 2)

The Alien Planet

343 - White Tree Forest
 158 - Cave (Scalloped Fang)
 341 - Jetty & Canoe
 289 - Primitive Natives; Box with Red Button (Pan-Dimensional Homing Device)

159 - Winged Scorpion
 359 - Carnivorous Plant
 235 - Red Shrubs (- ARMOUR)
 179 - Stairs into Chasm; Pool; Bi-Valve; Submarine up to 309

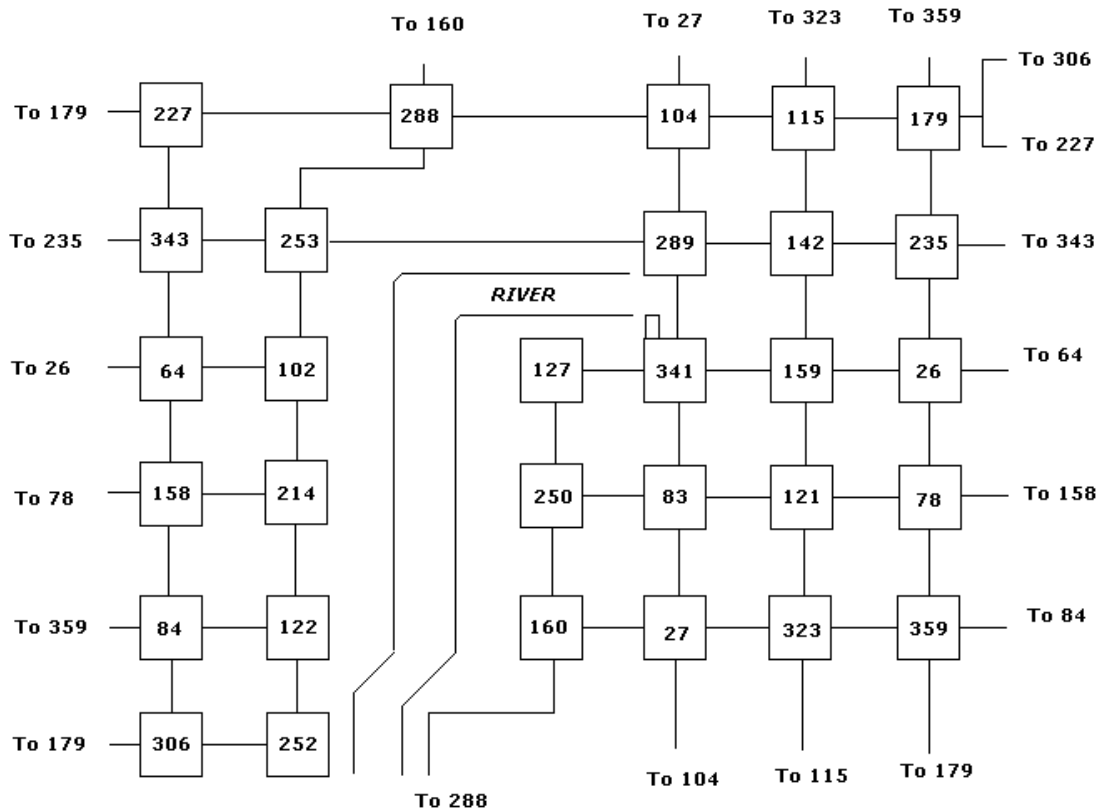

TEMPLE OF TERROR (PART 1)

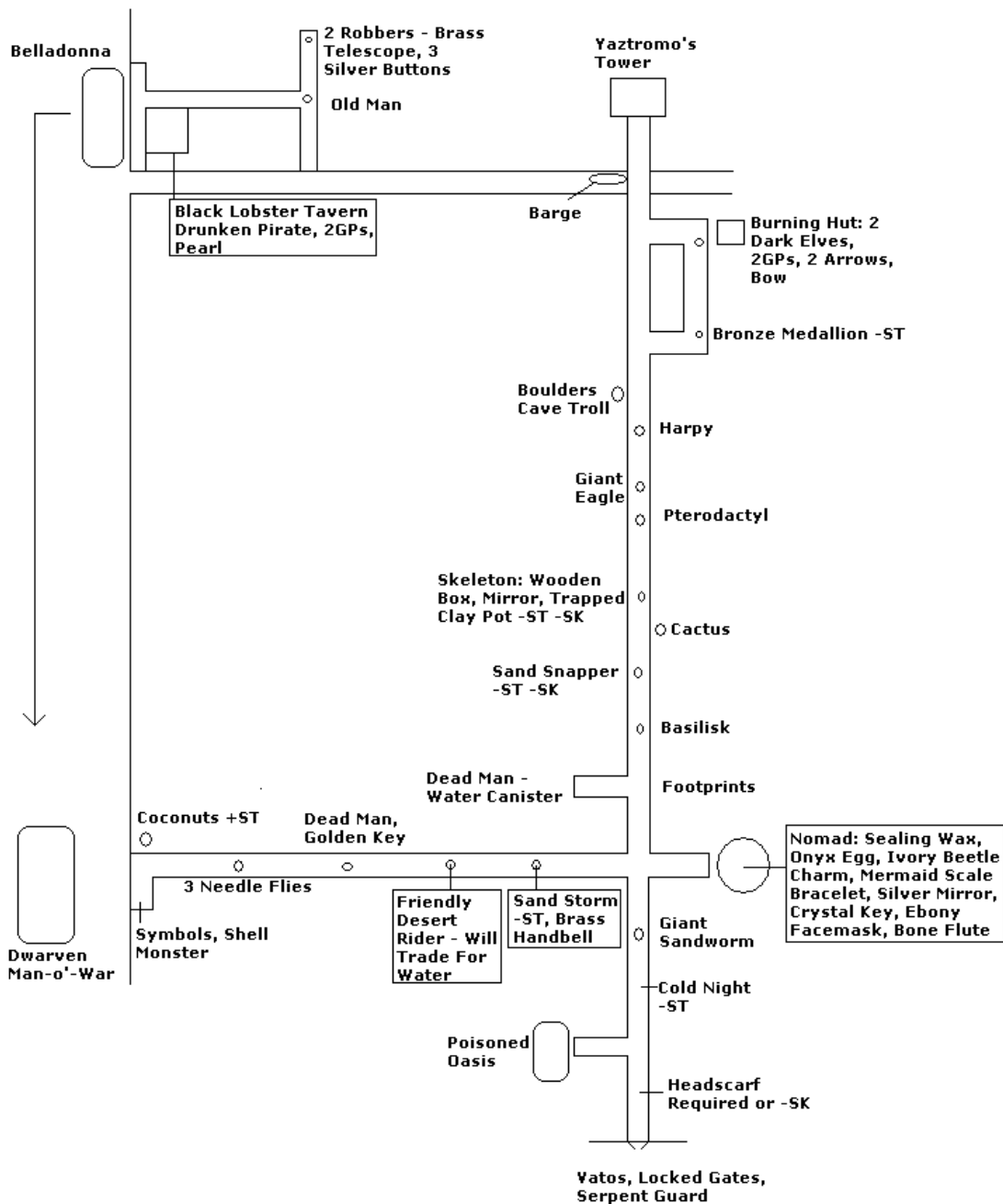

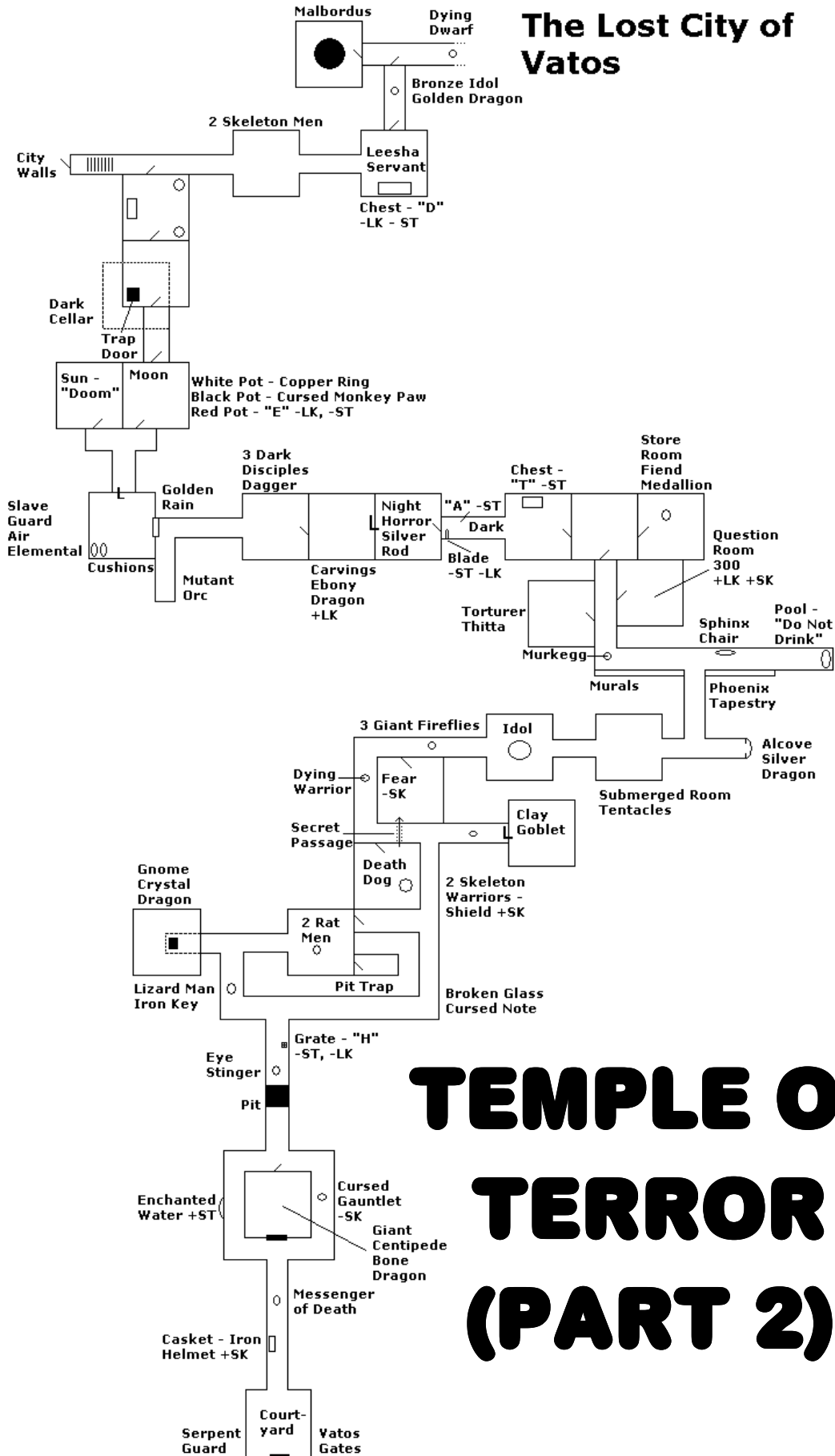

Trial of Champions

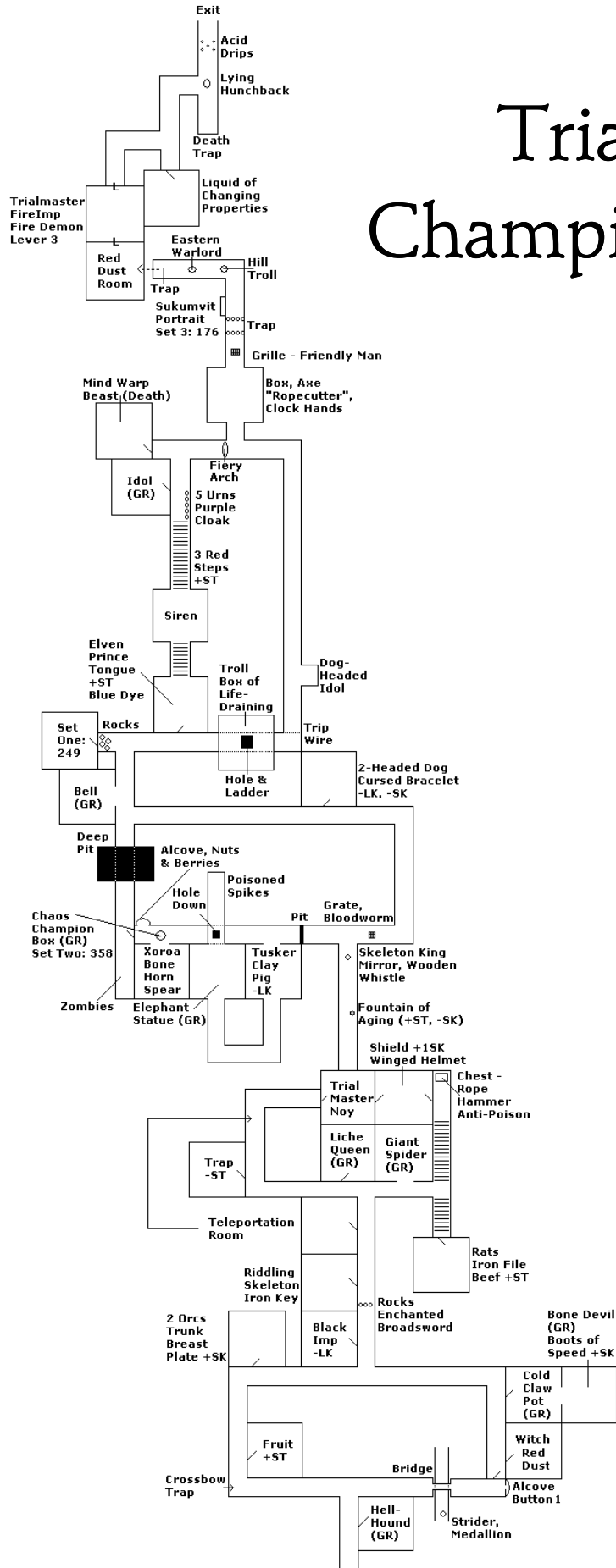

CREATURE OF HAVOC

(PART I)

Zharaddan Marr's
Dungeons - Creature of
Havoc Map 1

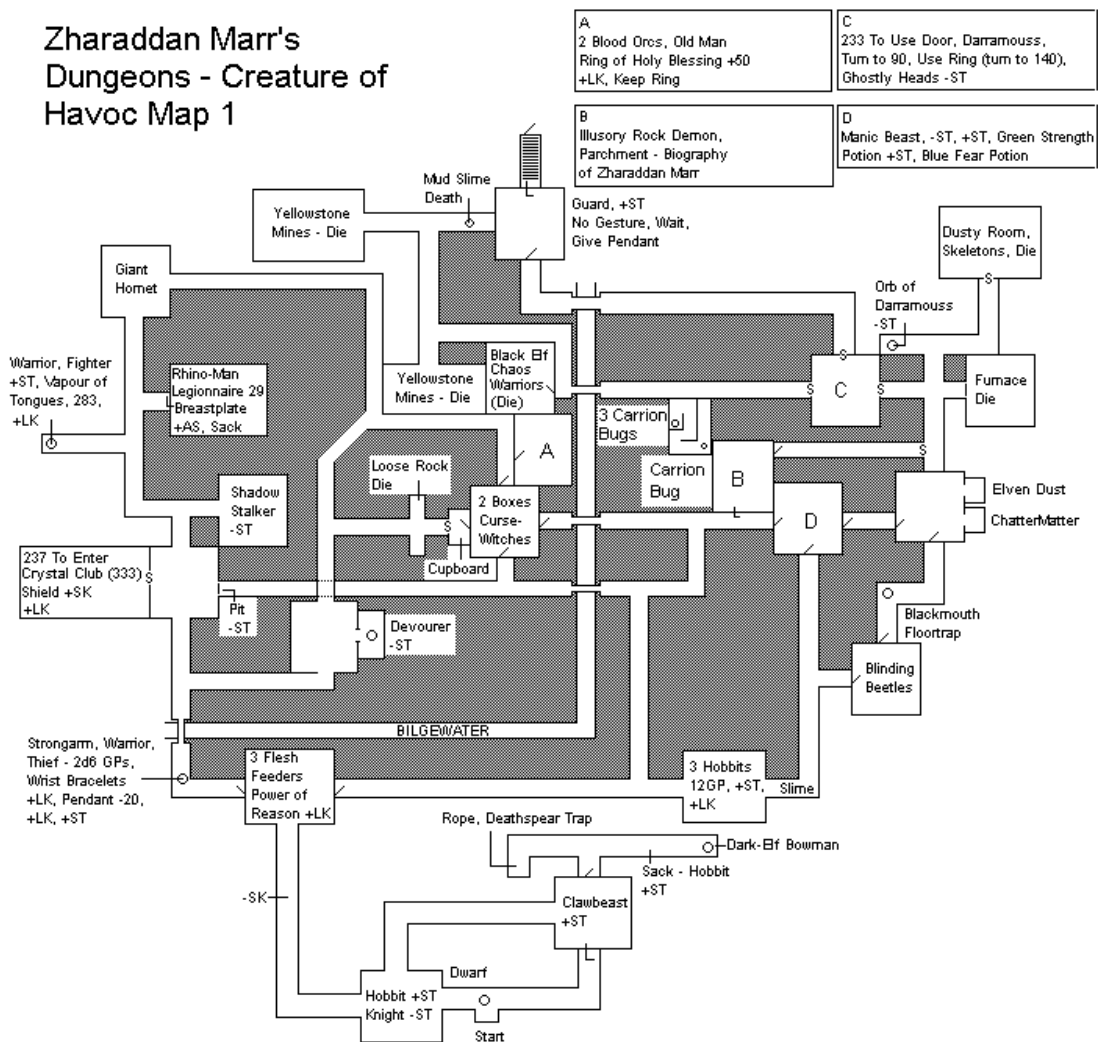

CREATURE OF HAVOC (TRANSLATIONS)

- 7 HAVE MERCY ON A BLIND MAN WHOEVER YOU ARE. IF YOU ARE FRIEND THEN LEAD ME FROM THIS PLACE. IF YOU ARE FOE THEN LEAVE ME BE. YOU ARE STRANGELY SILENT. WHO ARE YOU? DO YOU UNDERSTAND ME? MY GOD INTRUDER. IF YOUR PLAN IS TO DO AWAY WITH ME THEN DO IT QUICKLY. OTHERWISE BE OFF WITH YOU.
- IF YOU CAN UNDERSTAND THE HUMAN TURN TO REFERENCE TWO HUNDRED.
- SO WHAT IS IT TO BE? IS NOT MY MISERY ENOUGH? SHOW CHARITY. GIVE ME GOLD AND FEED ME. OR LEAVE ME BE.
- 86 CONTROL ITS MIND SHAMAN. IT MAY BE ABLE TO LEAD US TO THAT SWINEBEARD CUR!
- 104 OVER HERE. COME OVER HERE IF YOU WANT TO LEARN OF GREAT RICHES IN THESE PARTS. DO YOU NOT UNDERSTAND THE HUMAN TONGUE? PERHAPS THEN YOU SPEAK THE TROLL LANGUAGE.
- 147 I HAVE BEEN AWAKENED FROM MY SLUMBER! WHO CALLS ON THE VAPOUR OF TONGUES? THE HEAVENLY BODIES HAVE TAKEN THEIR POSITIONS. MY GIFT IS GRANTED. FOR BETTER OR FOR WORSE MY RELEASE BESTOWS ON YOU THE UNDERSTANDING YOU DESIRE. MAY YOU USE YOUR GIFT WISELY.
- 155 FOOLISH CREATURE. DID YOU THINK YOU COULD THIEVE THE ORB OF DARRAMOISS? NONE MAY TOUCH MY SACRED CRYSTAL FOR IT IS MY EYES AND EARS. AND MY WEAPONS YOU SHALL SEE.
- 160 CONTROL ITS MIND SHAMAN! IT MAY BE ABLE TO LEAD US TO THAT SWINEBEARD CUR!
- 185 LEAVE ME ALONE!
- 192 BIOGRAPHY OF ZMARR PAGE NINETY THREE.

...THUS CAME MARR TO ABANDON THE PHYSICAL WORLD AND TAKE REFUGE IN HIS OWN. A STRANGE NETHERWORLD WHICH OCCUPIES NO SPACE IN THE WORLD WE MORTALS KNOW. A WORLD OF ILLUSION IN WHICH WHERE HE APPEARS TO BE HE IS NOT. AND A WORLD IN WHICH THOSE SEARCHING FOR HIM WOULD INSTEAD FIND THEMSELVES. HE HAS BUT ONE WEAKNESS IN HIS NEW WORLD AND THAT IS A CRYSTAL CLUB WHICH MAY BE USED TO DESTROY FOREVER THE GATEWAY BETWEEN OUR WORLD AND HIS.

IF AT SOME TIME IN THE FUTURE YOU BELIEVE YOU HAVE LOCATED THE ENTRANCE TO MARR'S NETHERWORLD DEDUCT THE PAGE NUMBER ABOVE FROM THE REFERENCE YOU ARE ON AT THE TIME AND TURN TO THIS REFERENCE. IF YOU ARE CORRECT YOU WILL MEET THE NECROMANCER. FOR HAVING THE GOOD FORTUNE TO FIND THIS PARCHMENT YOU MAY RESTORE YOUR LUCK SCORE TO ITS INITIAL LEVEL.

217 WHO DISTURBS THE REST OF THE CURSEWITCHES? FOUL CREATURE YOU DABBLE WITH WHAT YOU DO NOT UNDERSTAND. NONE MAY INTERFERE WITH OUR PEACE SAVE FOR ZHARRADAN MARR THE MASTER. YOU MUST BE TAUGHT TO RESPECT THE SLEEP OF THE UNDEAD YOU MUST BE MADE TO FEEL THE WRATH OF THE CURSEWITCHES.

241 WHO IS IT? WHAT IS HAPPENING? WHAT HAS DISTURBED US? PLEASE GOD RELEASE THIS BLACK EYE CURSE.

337 SWINEBEARD OF YORE. YOU HAVE BEEN FOUND GUILTY OF THE CRIME OF WILFUL AND MALICIOUS ARSON A MOST SERIOUS OFFENCE IN THE DRY REGIONS OF SALAMONIS. AS PUNISHMENT YOU ARE SENTENCED TO UNDERTAKE A PERILOUS MISSION OF RECOVERY. YOU MUST TRAVEL NORTHWARDS AND ENTER THE UNDERGROUND DOMAIN OF ZHARRADAN MARR THERE TO SEEK OUT AND RECOVER FLASKS CONTAINING SWIRLING VAPOURS. THESE ARE THE VAPOURS OF STITTLE WOAD. YOU MUST FIND THE THREE FLASKS CONTAINING THESE VAPOURS AND RETURN THEM TO THIS COURT. ON NO ACCOUNT MUST THEY BE OPENED. THIS IS THE SENTENCE OF THE COURT AND THE GEAS HAS BEEN CAST. THIS IS YOUR PUNISHMENT. YOU MUST SUCCEED IN YOUR MISSION OR DIE IN THE ATTEMPT.

VAPOUR OF KNOWLEDGE / — FLAXENMANE OF SILVERTON = / WINGED HELMET.

364 KEEP AWAY FROM ME.

369 YOUR PROGRESS HAS BEEN WATCHED FOUL CREATURE OF DESTRUCTION. SO FAR YOU HAVE DONE WELL THOUGH YOU KNOW NOT WHO OR WHAT. BUT YOU HAVE CAUSED TWO OF THE VAPOURS TO BE LOST. ZHARRADAN MARR HIMSELF HAS DECREED YOUR DESTINY. YOU SHALL REMAIN IN HIS DUNGEONS AND DO MY BIDDING. FOR I AM DARRAMOISS YOUR MASTER.

IF YOU CAN UNDERSTAND HIM TURN TO REFERENCE NINETY.

YOUR FIRST ORDER IS THIS. REPORT FOR DUTY AT THE YELLOWSTONE MINES. LEAVE NOW AND HEAD THERE IMMEDIATELY. I WILL BE WATCHING.

382 I AM RELEASED FROM MY REST. FOUL CREATURE WHAT DO YOU KNOW OF THE FORCES WITH WHICH YOU TAMPER? BUT NONETHELESS MY PURPOSE IS ORDAINED. I BESTOW ON YOU THE POWER OF REASON. FROM NOW ON YOU ARE IN CONTROL OF YOUR OWN DESTINY. AND NOW MAY I RETURN TO MY PEACEFUL REST UNTIL ONCE MORE THE HEAVENS TAKE THEIR POSITIONS.

392 YOU ARE NOW UNDER MY CONTROL FOUL CREATURE. ALL MY WISHES ARE YOUR COMMANDS. GATHER MY COMRADES AND FOLLOW ME.

425 YELLOWSTONE MINES. SERGEANTS AND SLAVES ONLY.

NO NEED TO BOIL YOUR BLOOD. WHAT IS IT YOU WANT IN THE MINES? IF IT'S WORK THEN COME BACK TOMORROW. A FEW OF THE SLAVES WILL DOUBTLESS DIE TODAY.

435 COME ON THEN. WHAT BUSINESS HAVE YOU HERE? ANSWER QUICKLY.

IF YOU CAN UNDERSTAND THE CREATURE TURN IMMEDIATELY TO REFERENCE SIXTY TWO.

LOST YOUR TONGUE EH? THEN BEGONE. BE OFF WITH YOU BEFORE I DECIDE TO HAVE A LITTLE BATTLE PRACTICE.

441 YELLOWSTONE MINES THIS WAY.

Fighting Fantasy Solution Maps

Armies of Death (Part 2)

Vault of the Vampire

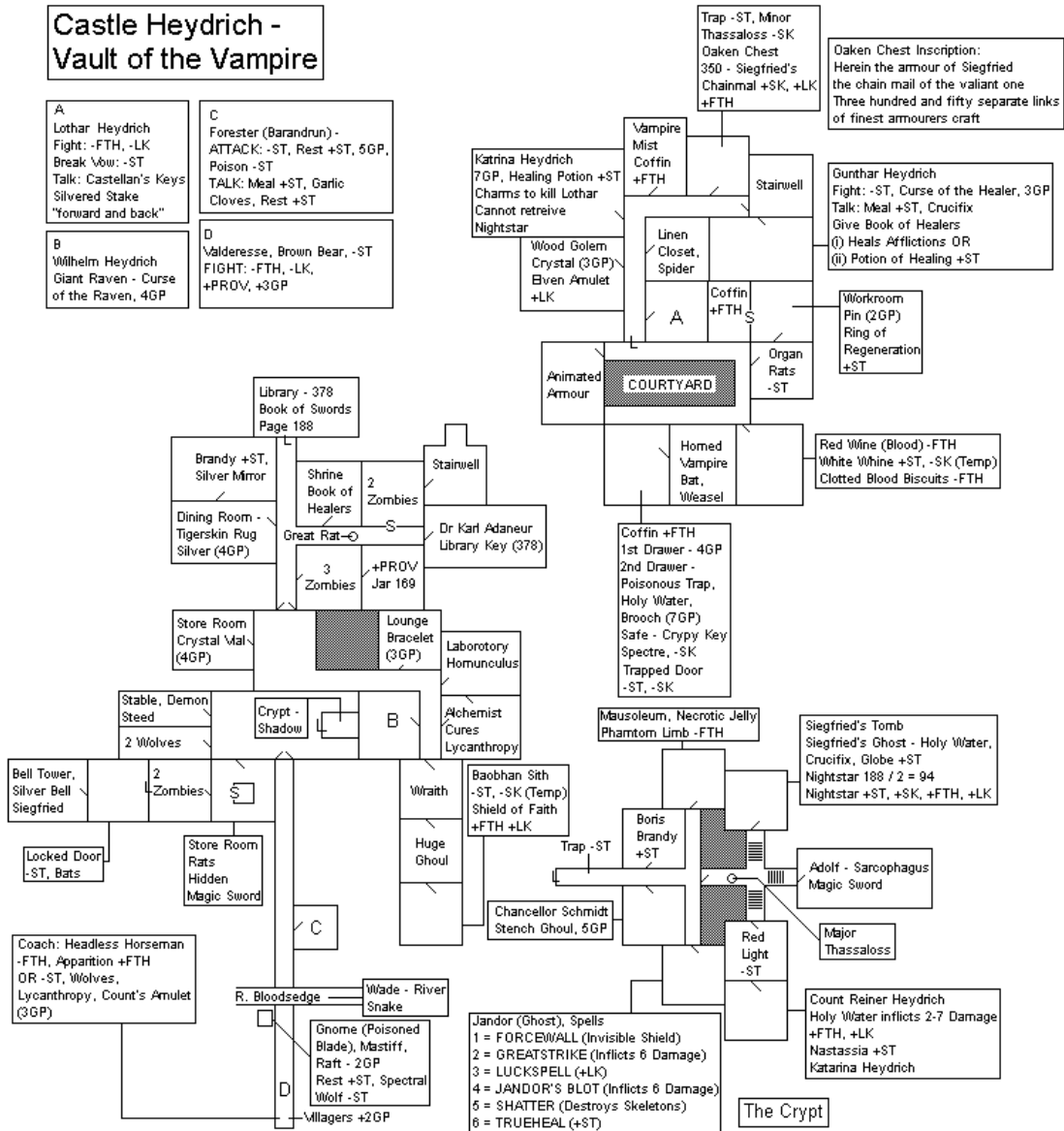

Return to Firetop Mountain

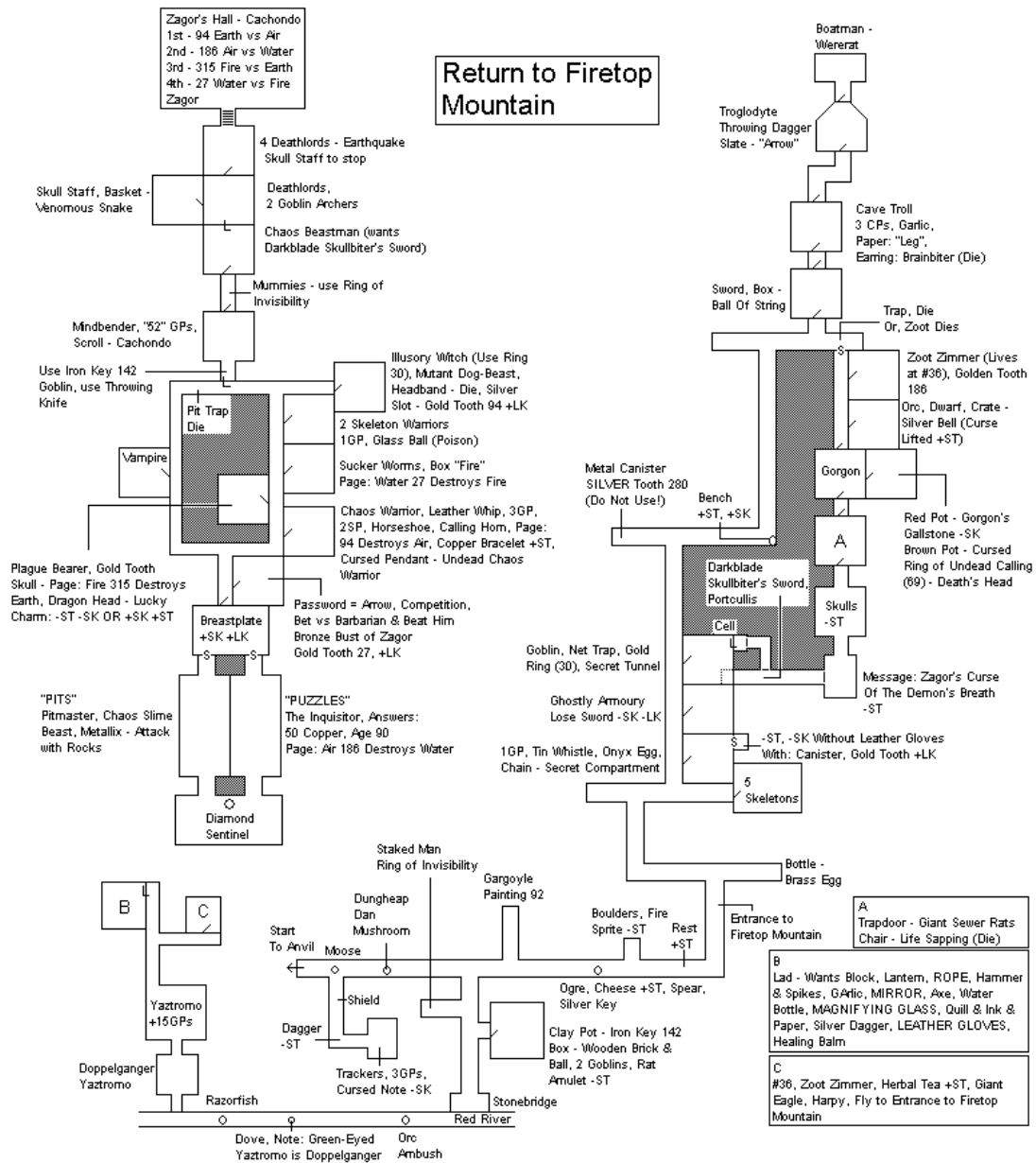

Legend of Zagor (Part 1)

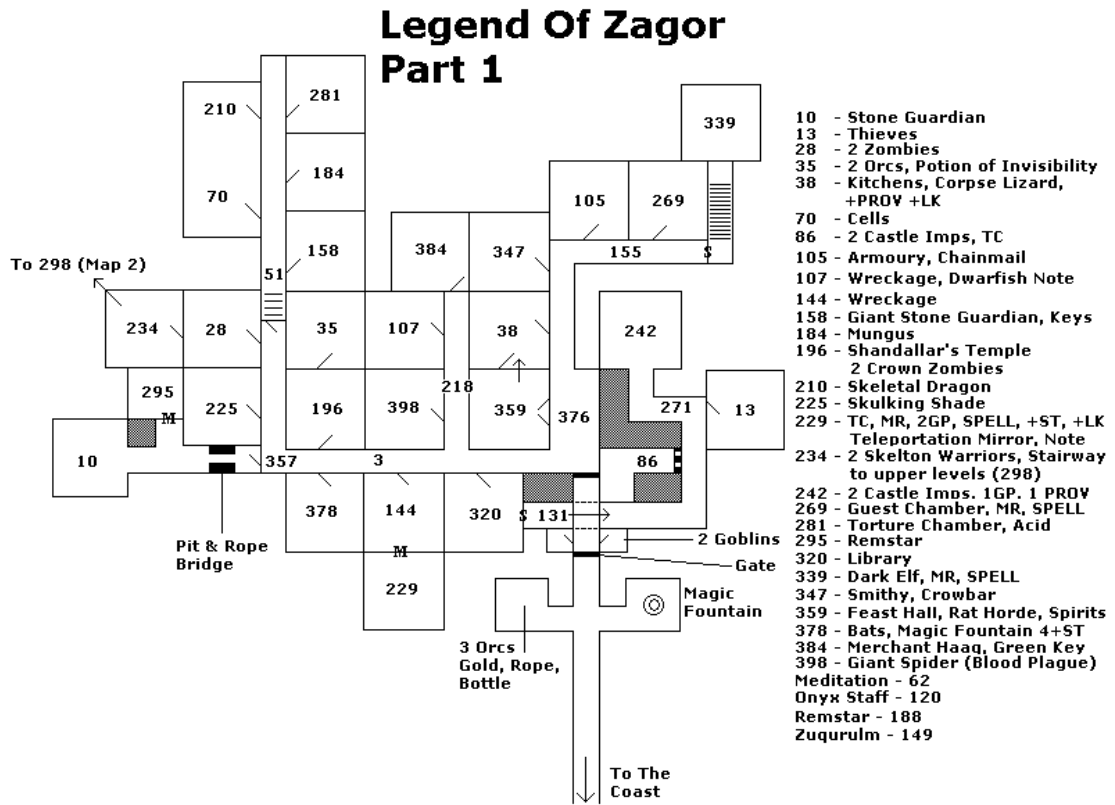

Legend of Zagor (Part 2)

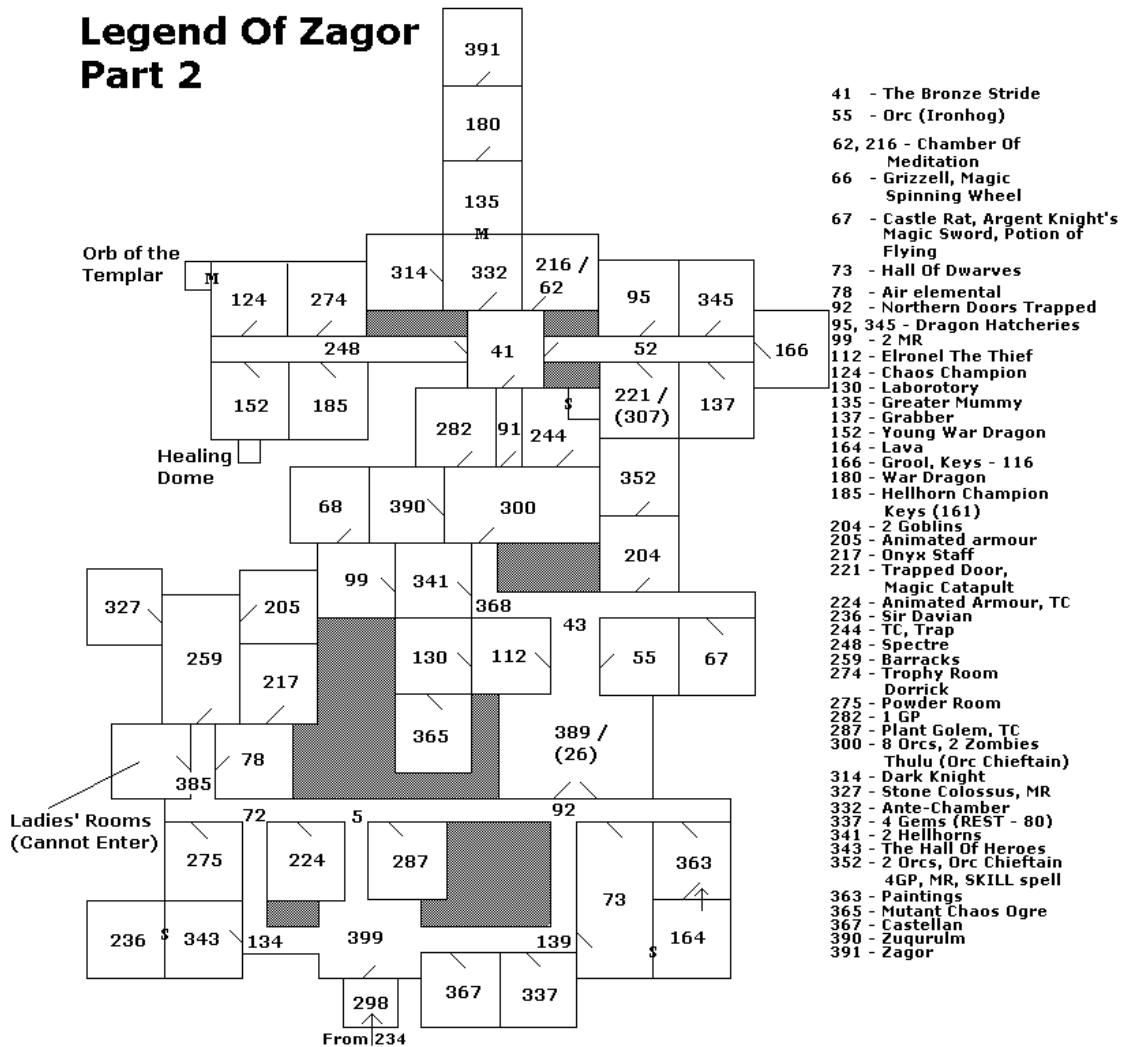

Rogue Mage

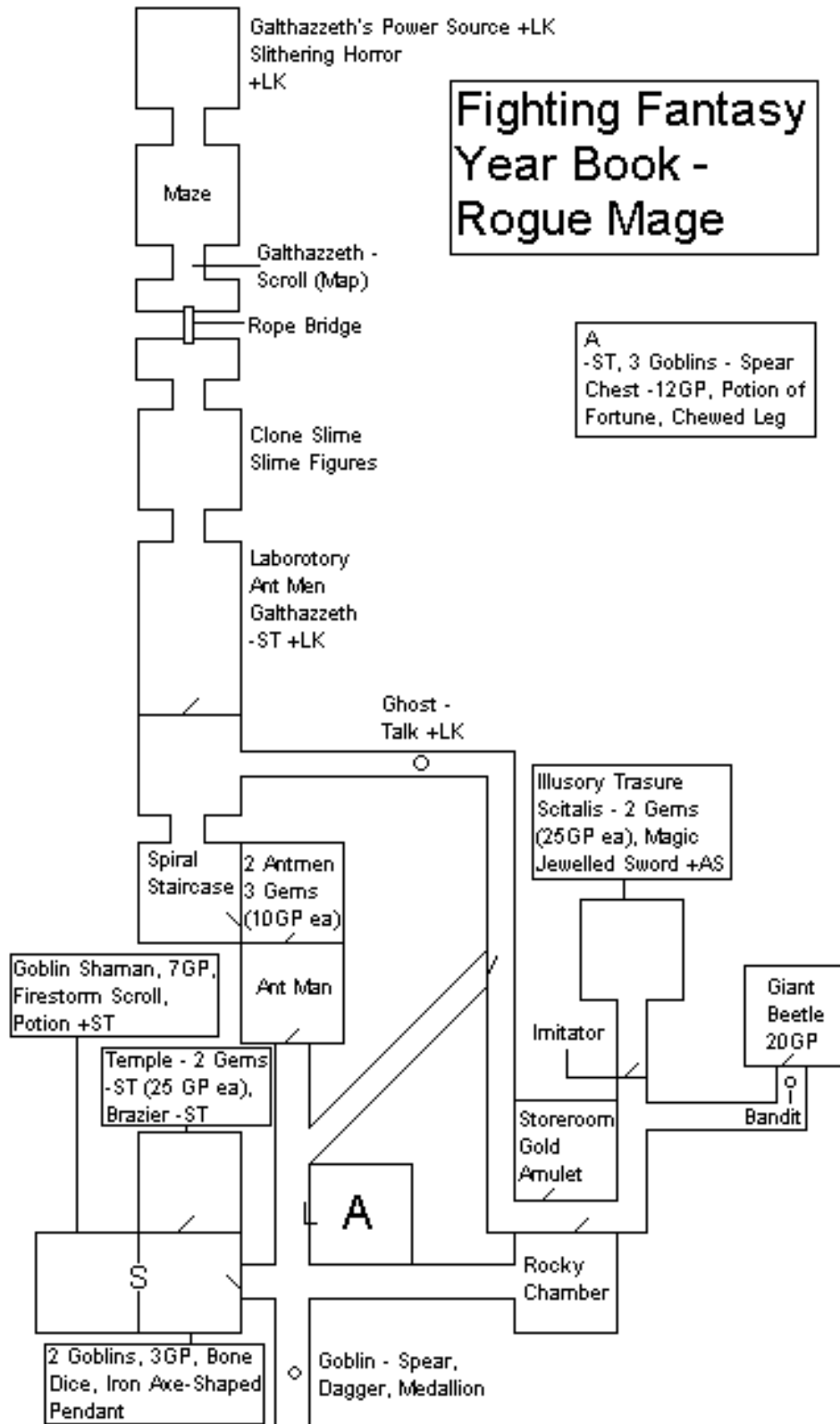

Sorcery 1: The Shamutanti Hills

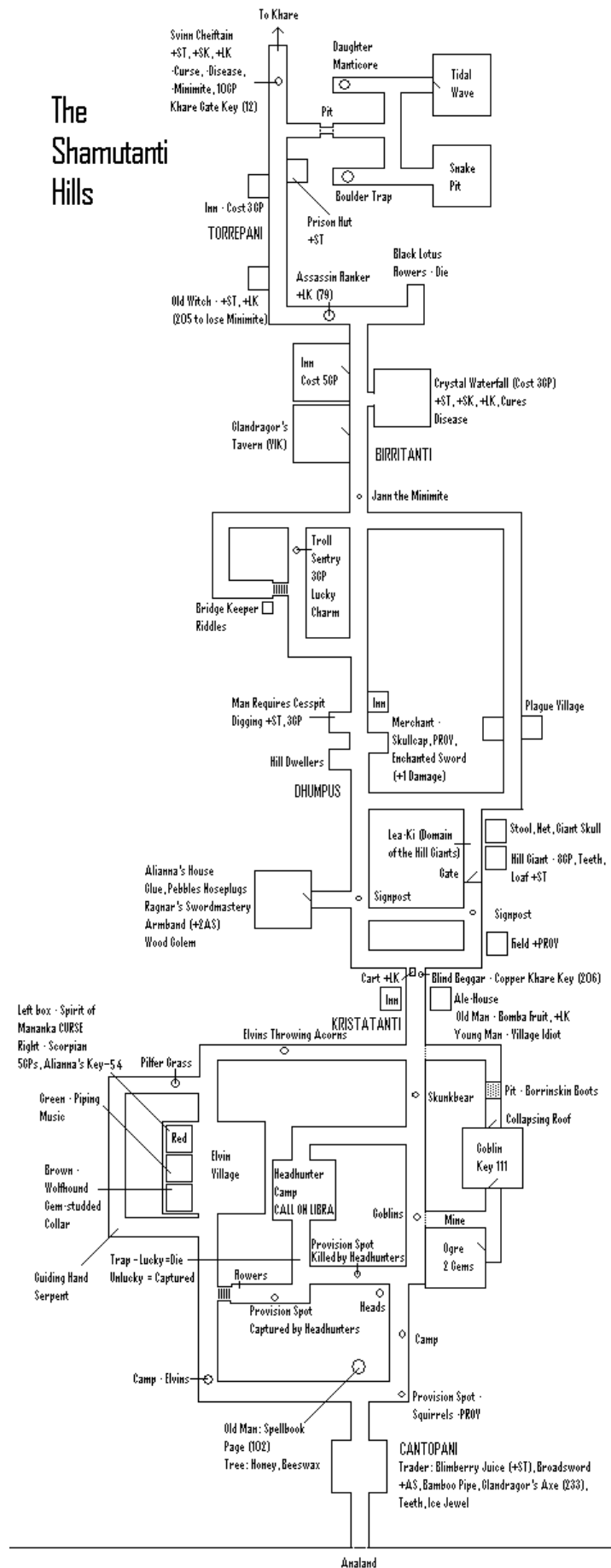

Sorcery 2: Kharé—Cityport of Traps

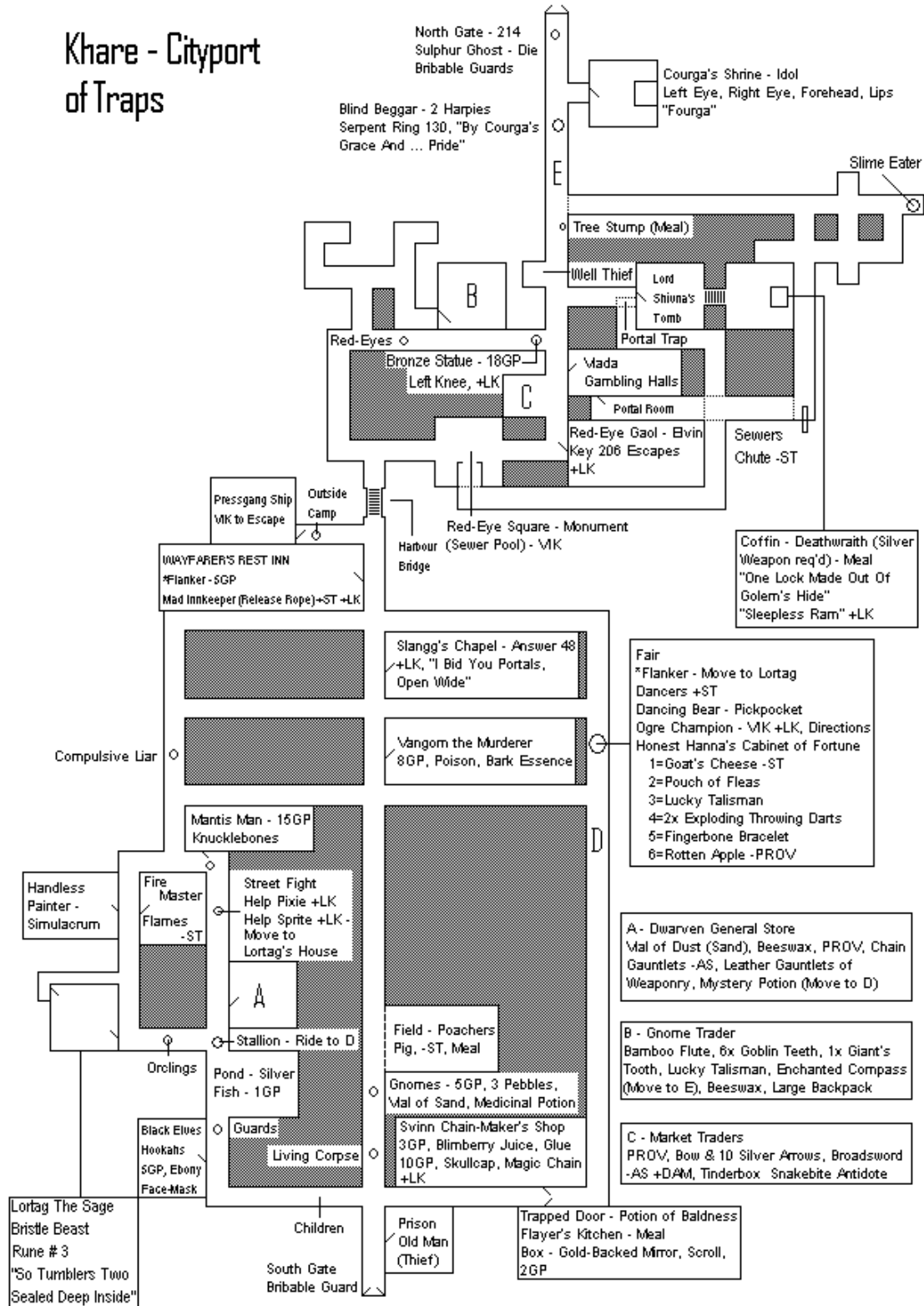

Sorcery 3: The Seven Serpents

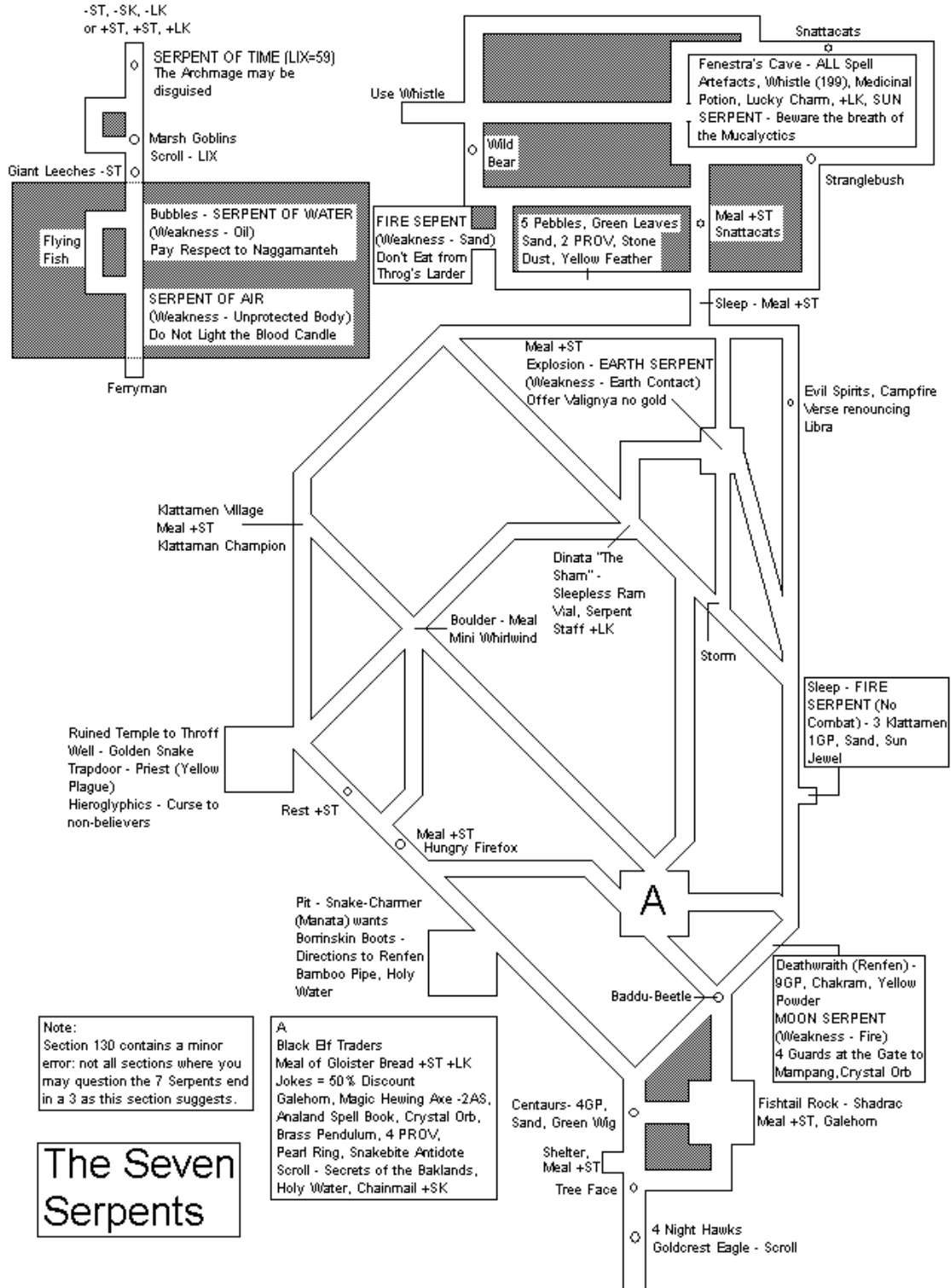

Sorcery 4: The Crown of Kings

